

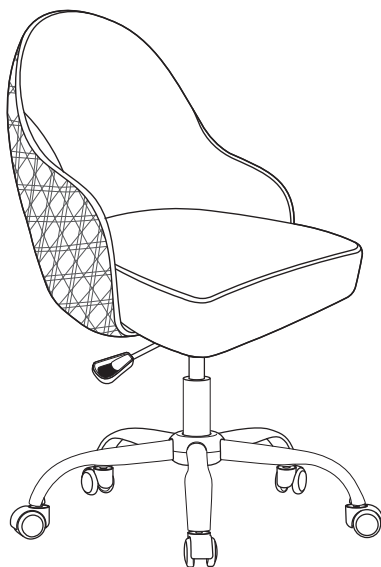

Blake Technician Chair







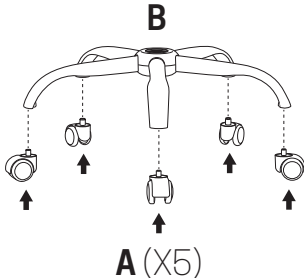
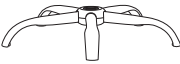
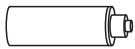
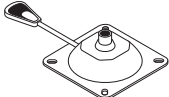
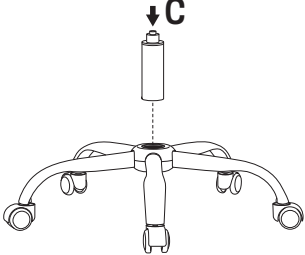

Model: TT4
Customization
Grey

User Manual

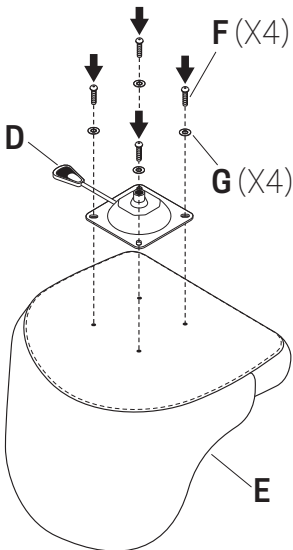
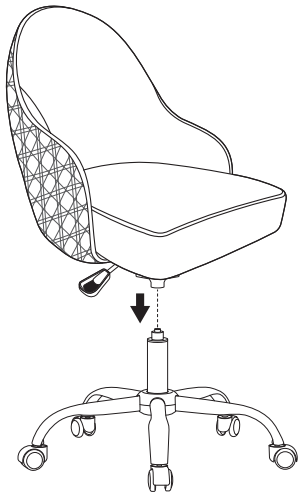
Ergonomic and fully adjustable
manicure technician chair

ASSEMBLY

<p>A x5</p> 	<p>1</p>  <p>B x1</p>  <p>C x1</p>  <p>D x1</p>  <p>A (X5)</p>	<p>2</p> 	
<p>E x1</p> 		<p>3</p>  <p>F (X4)</p> <p>G (X4)</p> <p>D</p> <p>E</p>	<p>4</p> 
<p>F x4</p> 			
<p>G x4</p> 			
<p>H x1</p> 			

COMPONENTS

1 | Wheels (x5)

Allow chair free movement. Heavy duty PU wheels with PP covers to protect them from dust and dirt.

2 | Star metal base

Ensures the stability and safety of the chair. Steel frame with chrome plating, withstands up to 200 lb (90 kg) of weight.

3 | Chrome gas lift cylinder

Allows to adjust height up to 4.7" (12 cm). Nitrogen filled to ensure a safe use.

4 | Center pivot mechanism

Heavy duty height control mechanism.

- To raise, pull lever upward and raise your body to allow the chair to rise to the desired height.
- To lower, pull lever upward and apply weight downwards on the seat.

5 | Seat and backrest cushioning

Soft cushioned seat and backrest with acetone resistant upholstery. Innerspring cushioning to ensure durability and preserve seat shape.

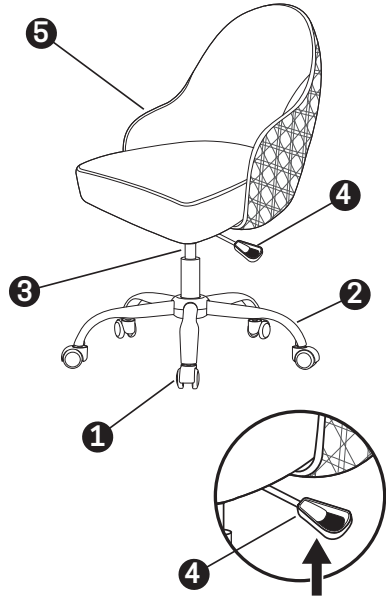

MAINTENANCE RECOMMENDATIONS

At the end every work day, clean with a cleaning solution or sanitizer.

Intense industrial use can wear the wheels and gas lift cylinder over time. You should replace your chair's wheels and cylinder every few years or when they start to show signs of wear and tear. Regular maintenance and checking for any issues can help prolong their lifespan.



STATE OF CALIFORNIA PROPOSITION 65 WARNING

Product may contain one or more chemicals known to the State of California to cause cancer or reproductive harm. For more information, go to www.p65warnings.ca.gov

TECHNICAL SPECIFICATIONS		
Dimensions	Height	18.5" Lowest 23.2" Highest
	Width	20"
	Depth	19"
	Maximum weight capacity	200 lb
Acetone resistant	Yes	
Chair legs material	Steel	
Upholstering fill material	Foam	
Upholstery material	Vegan leather	
Swivel	Yes	
Assembly required	Yes (all required tools included)	
Wheels	Included 5 wheels	
Warranty	6 Months	
Importer	T-SPA MFG, LLC	
Manufacturer	Anji Maochang Furniture Co., LTD	

T-SPA[®]
WWW.TSPALLC.COM

T-SPA MFG, LLC
10510 Kinghurst Dr
Houston, TX 77099
1(888)508-8772
Info@tspallc.com