

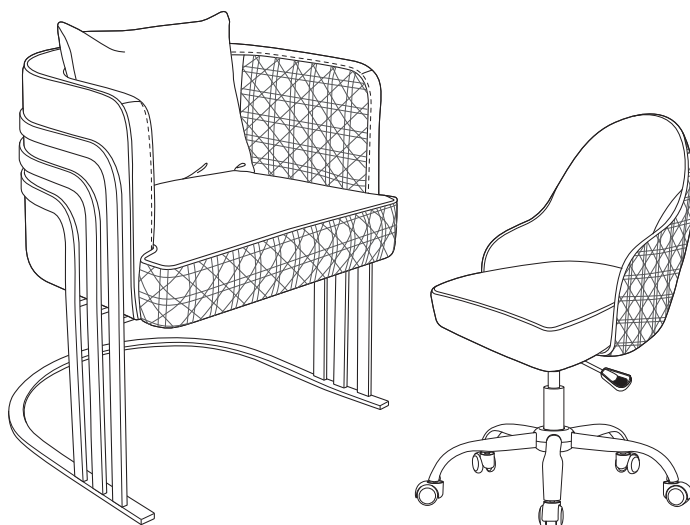

Blake Chair Combo



Models: TC13 + TT4

Customization

Grey

User Manual

Ergonomic and adjustable manicure
customer and technician chair combo

CUSTOMER CHAIR INSTALLATION

This product comes pre-assembled. No further assembly procedures are required.

Adjust the Foot Levelers

The chair has foot levelers on the bottom to ensure that it can sit evenly on uneven floors and prevent wobbling.

If the chair is unbalanced, twist the levelers clockwise to increase the height or counterclockwise to decrease it. Adjust each one until the chair is evenly supported.

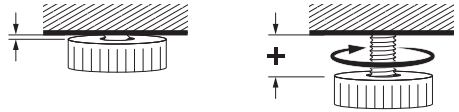
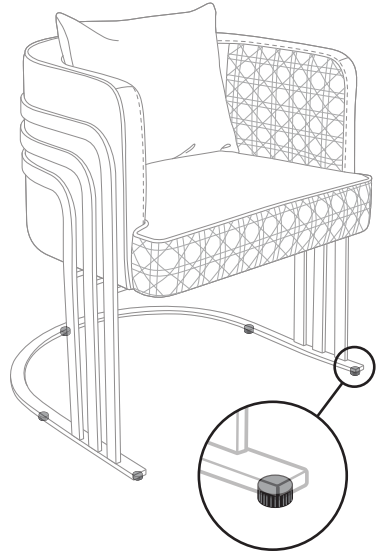

COMPONENTS

1 | Seat and backrest cushioning





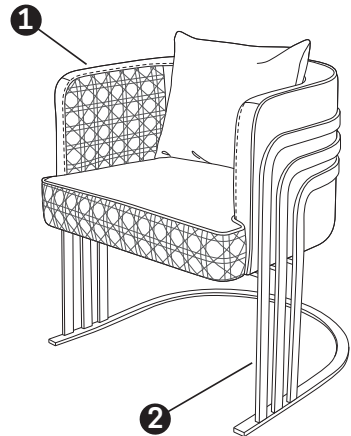

Soft cushioned seat and backrest with acetone resistant upholstery. Innerspring cushioning to ensure durability and preserve seat shape.

2 | Steel leg frame

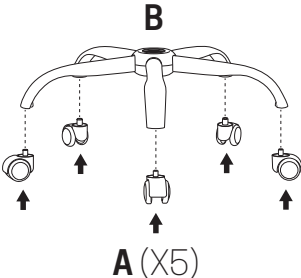
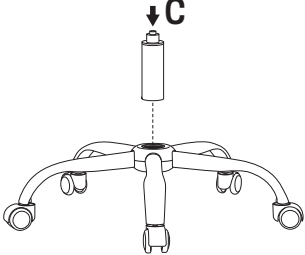
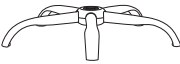
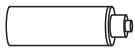
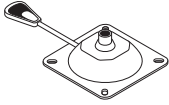
Heavy duty iron leg frame, provides durability and stability.

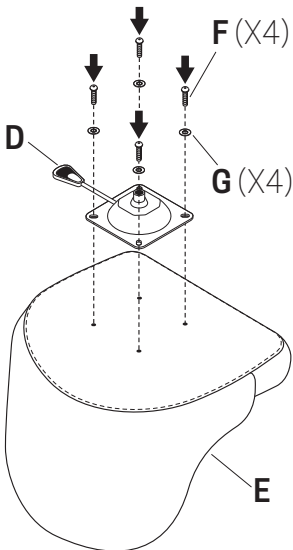
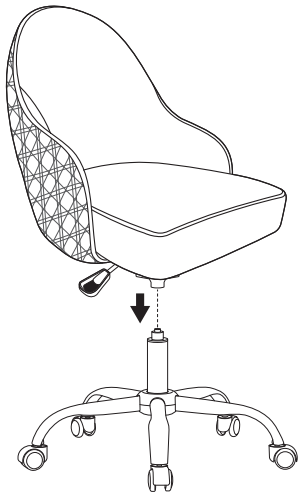

TECHNICIAN CHAIR ASSEMBLY

<p>A x5</p> 	<p>1</p>  <p>B</p> <p>A (X5)</p>	<p>2</p>  <p>C</p>
<p>B x1</p> 		
<p>C x1</p> 		
<p>D x1</p> 		
<p>E x1</p> 	<p>3</p>  <p>D</p> <p>F (X4)</p> <p>G (X4)</p> <p>E</p>	<p>4</p> 
<p>F x4</p> 		
<p>G x4</p> 		
<p>H x1</p> 		

TECHNICIAN CHAIR COMPONENTS

1 | Wheels (x5)

Allow chair free movement. Heavy duty PU wheels with PP covers to protect them from dust and dirt.

2 | Star metal base

Ensures the stability and safety of the chair. Steel frame with chrome plating, withstands up to 200 lb (90 kg) of weight.

3 | Chrome gas lift cylinder

Allows to adjust height up to 3.1" (8 cm). Nitrogen filled to ensure a safe use.

4 | Center pivot mechanism

Heavy duty height control mechanism.

- To raise, pull lever upward and raise your body to allow the chair to rise to the desired height.
- To lower, pull lever upward and apply weight downwards on the seat.

5 | Seat and backrest cushioning

Soft cushioned seat and backrest with acetone resistant upholstery. Innerspring cushioning to ensure durability and preserve seat shape.

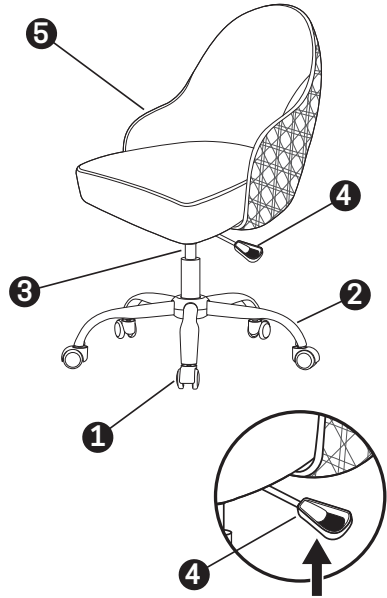

MAINTENANCE RECOMMENDATIONS

Use a cleaning solution or sanitizer to clean the chairs. Clean the customer chair after every service, and the technician chair at the end every work day.

Intense industrial use can wear the wheels and gas lift cylinder over time. You should replace your chair's wheels and cylinder every few years or when they start to show signs of wear and tear. Regular maintenance and checking for any issues can help prolong their lifespan.



STATE OF CALIFORNIA PROPOSITION 65 WARNING

Product may contain one or more chemicals known to the State of California to cause cancer or reproductive harm. For more information, go to www.p65warnings.ca.gov

TECHNICAL SPECIFICATIONS		
	CUSTOMER CHAIR	TECHNICIAN CHAIR
Model	TC13	TT4
Dimensions	Height	19.5"
		18.5" Lowest
		21.5" Highest
	Width	28"
	Depth	18"
Maximum weight capacity	250 lb	200 lb
Acetone resistant	Yes	Yes
Chair legs material	Iron	Steel
Upholstering fill material	Foam	Foam
Upholstery material	Vegan leather	Vegan leather
Swivel	No	Yes
Assembly required	No	Yes
Wheels	No	Included 5 wheels
Warranty	6 Months	
Importer	T-SPA MFG, LLC	
Manufacturer	Anji Maochang Furniture Co., LT	

T-SPA[™]
WWW.TSPALLC.COM

T-SPA MFG, LLC
10510 Kinghurst Dr
Houston, TX 77099
1(888)508-8772
Info@tspallc.com