

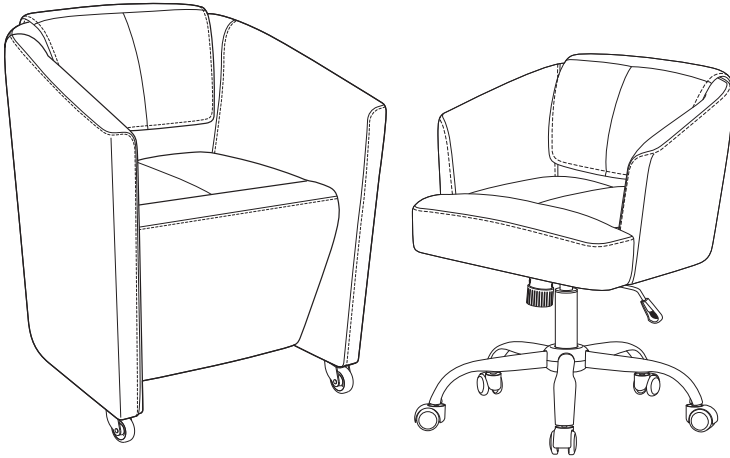

Barron Chair Combo



Models: TC12 + TT12

Customization

Black
Chocolate
Grey
Khaki
Mocha

User Manual

Ergonomic and adjustable manicure
customer and technician chair combo

CUSTOMER CHAIR ASSEMBLY

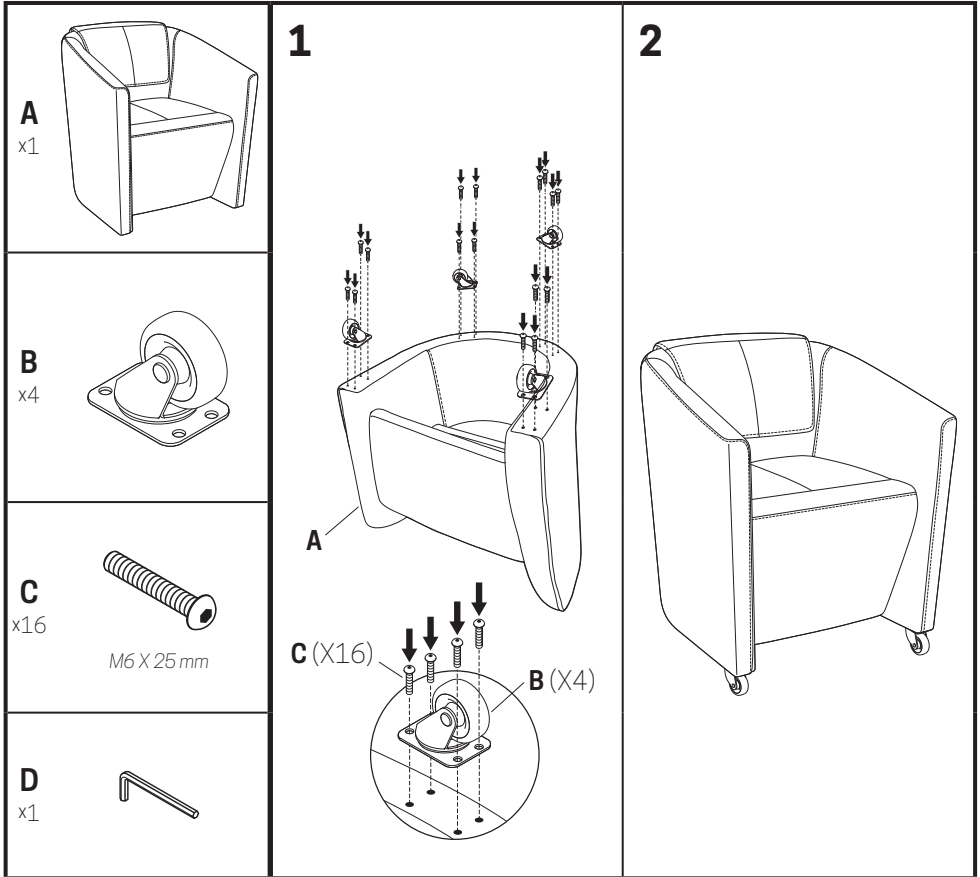

CUSTOMER CHAIR COMPONENTS

1 | Wheels (x4)





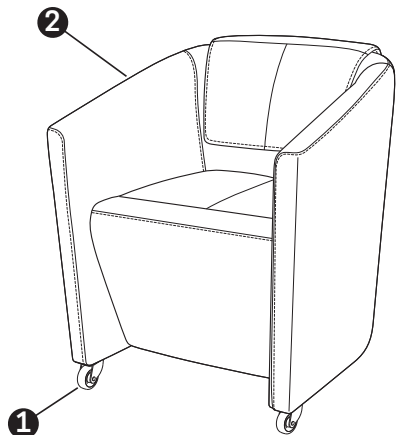

Allow chair free movement. Heavy duty PU wheels.

2 | Seat and backrest cushioning

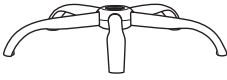
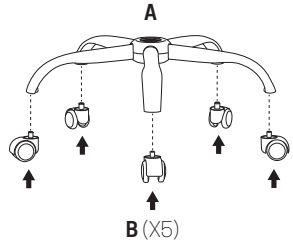
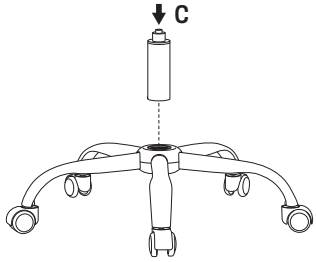
Soft cushioned seat and backrest with acetone resistant upholstery. Innerspring cushioning to ensure durability and preserve seat shape.

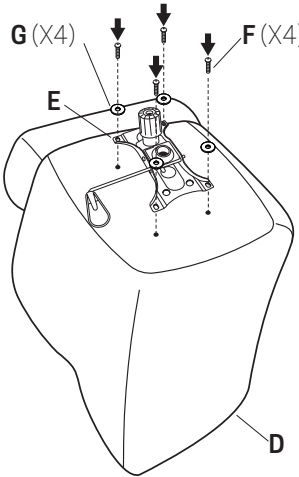
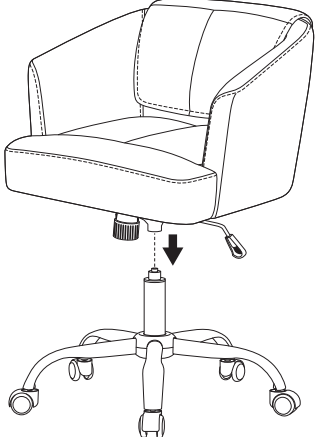
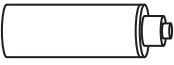
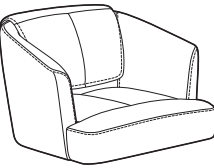
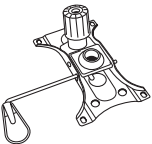
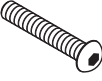

TECHNICIAN CHAIR ASSEMBLY

<p>A × 1</p> 	<p>1</p>  <p>B (X5)</p>	<p>2</p>  <p>C</p>
<p>B × 5</p> 	<p>3</p>  <p>G (X4)</p> <p>F (X4)</p> <p>E</p> <p>D</p>	<p>4</p> 
<p>C × 1</p> 	<p>D × 1</p> 	<p>E × 1</p> 
<p>F × 4</p>  <p>M6 X 25 mm</p>	<p>5</p> 	<p>G × 4</p> 
<p>H × 1</p> 		

TECHNICIAN CHAIR COMPONENTS

1 | Wheels (x5)

Allow chair free movement. Heavy duty PU wheels with PP covers to protect them from dust and dirt.

2 | Star metal base

Ensures the stability and safety of the chair. Diameter steel frame with chrome plating, withstands up to 200 lb (90 kg) of weight.

3 | Chrome gas lift

Allows to adjust height up to 4.7" (12 cm). Nitrogen filled to ensure a safe use.

4 | Center pivot (butterfly) mechanism

Heavy duty height and tilt control mechanism.

5 | Seat, backrest and armrests cushioning

Soft cushioned seat and backrest with acetone resistant upholstery. Innerspring cushioning to ensure durability and preserve seat shape.

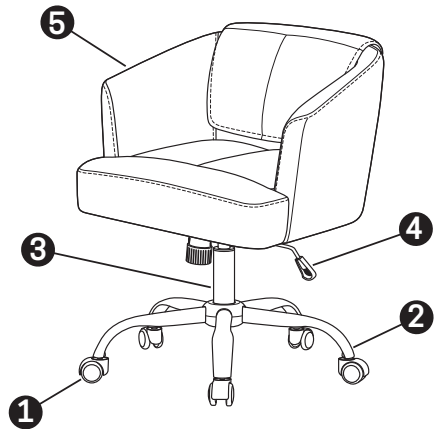

MAINTENANCE RECOMMENDATIONS

Use a cleaning solution or sanitizer to clean the chairs. Clean the customer chair after every service, and the technician chair at the end every work day.

Intense industrial use can wear the wheels and gas lift cylinder over time. You should replace your chair's wheels and cylinder every few years or when they start to show signs of wear and tear. Regular maintenance and checking for any issues can help prolong their lifespan.

	STATE OF CALIFORNIA PROPOSITION 65 WARNING
Product may contain one or more chemicals known to the State of California to cause cancer or reproductive harm.	
For more information, go to www.p65warnings.ca.gov	

TECHNICAL SPECIFICATIONS		
	CUSTOMER CHAIR	TECHNICIAN CHAIR
Model	TT12	TC12
Dimensions	Height	19.5"
		21" Lowest 25.7" Highest
	Width	28"
	Depth	18"
Maximum weight capacity	250 lb	200 lb
Acetone resistant	Yes	Yes
Chair legs material	Steel	Steel
Upholstering fill material	Foam	Foam
Upholstery material	Vegan leather	Vegan leather
Swivel	Yes	Yes
Assembly required	Yes (all required tools included)	
Wheels	Included 4 wheels	Included 5 wheels
Warranty	6 Months	
Importer	T-SPA MFG, LLC	
Manufacturer	Anji Maochang Furniture Co., LT	

T-SPA[®]
WWW.TSPALLC.COM

T-SPA MFG, LLC
10510 Kinghurst Dr
Houston, TX 77099
1(888)508-8772
Info@tspallc.com