

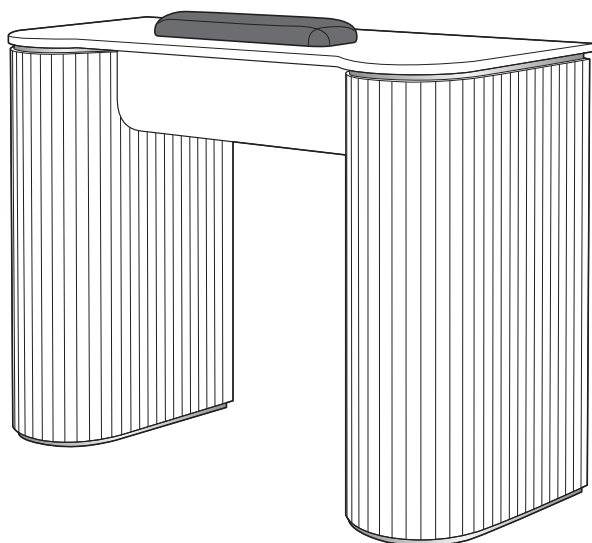

Laucetta







Single Table

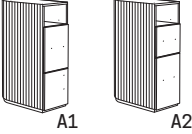
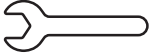
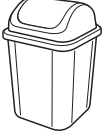
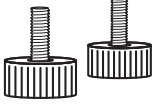

User Manual

Ergonomic and elegant
manicure single table

ASSEMBLY

<p>A (x2) Table Legs</p> 	<p>B (x1) Wrench</p> 	<p>C (x1) Trash Bin</p> 	<p>D (x8) Rubber Feet</p> 
<p>E (x1) Top Drawer</p> 	<p>F (x8) M3x6 Screw & Washer</p> 	<p>G (x1) Key Wrench</p> 	<p>H (x5) Pull Handles</p> 
<p>I (x1) Marble Countertop</p> 	<p>J (x1) Hand Rest Cushion</p> 		

1. Unpack the components

The Table Legs (A) are secured together with bolts and nuts inside the packaging to protect them during transport. Using the Wrench (B), remove the bolts and separate the legs before beginning assembly. The bolts and nuts removed in this step will not be reused.

Locate the Trash Bin (C) in the lower drawer of the right leg (A2). All the hardware required for assembly is stored inside the trash bin.

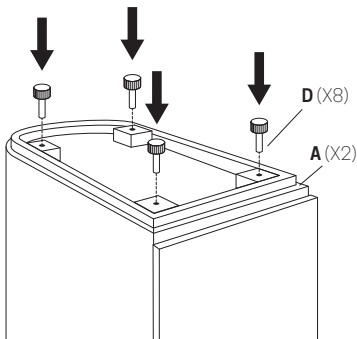
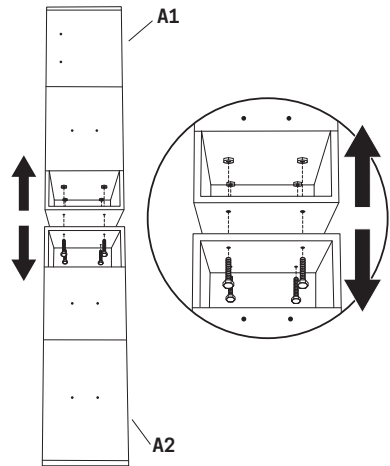

2. Attach Rubber Feet

Insert the Rubber Feet (D) into the 4 holes at the bottom of each Table Leg (A).

3. Assemble Table Legs to Top Drawer

Attach the left leg (A1) and right leg (A2) to the Top Drawer (E) using the Screws (F) and the Allen Key Wrench (G).

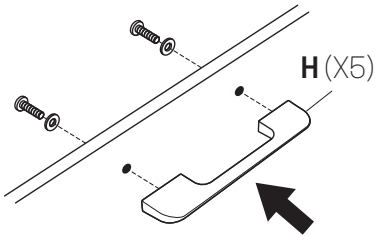
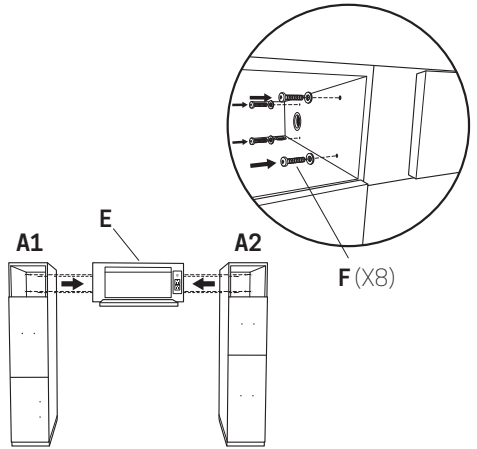

4. Assemble Pull Handles

The Pull Handles (H) are pre-installed on the inside to protect them during transport. Unscrew each handle and reattach it to the exterior side.



5. Recommended: Fasten Countertop

Fasten the Marble Countertop (I) to the top of the table using glue or silicon (not included).

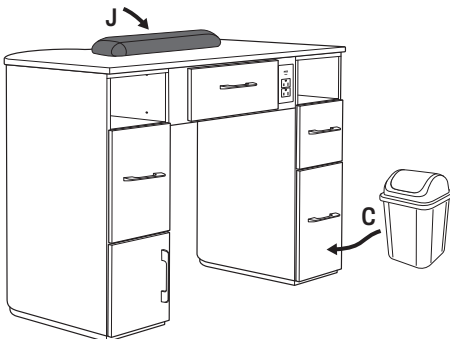

6. Finished assembly

The table is now fully assembled. Remember to put the Trash Bin (C) back into the drawer where it came and place the Hand Rest Cushion (J) on the Countertop.

FEATURES

1 | Elegant Design

Elevates your saloon style with an elegant design with marble quartz countertop and silver accents.

2 | Storage

Five drawers and two open shelves to have everything you need close at hand.

3 | Power Hub

Embedded power outlets available to connect from every drawer.

- 2 AC Outlets
- 1 Fast charging USB-A port
- 1 Fast charging USB-C port

4 | Trash Bin

Includes a concealed trash bin drawer to help maintain a clean and tidy workstation.

5 | Rubber Feet

Heavy duty rubber feet. Provide a stable support while protecting table and floor from scratches and wear.

6 | Hand Rest Cushion

PU, acetone resistant nail cushion accessory.

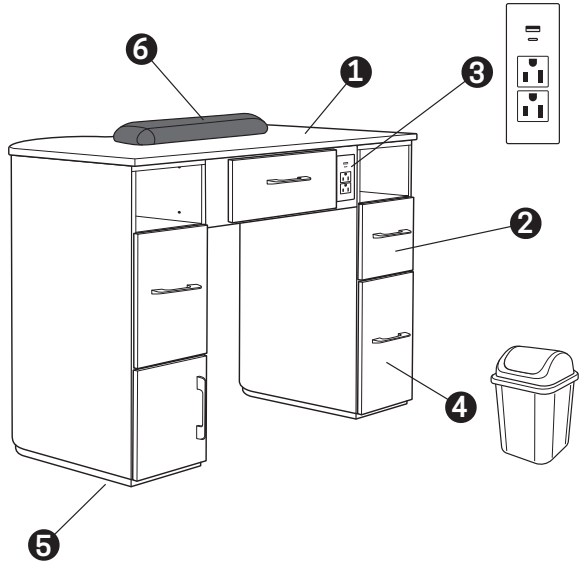

MAINTENANCE RECOMMENDATIONS

- Clean the table and all accessories after each service using an appropriate cleaning solution or sanitizer.
- With intensive, high-volume use, some components —such as drawer hardware and rubber feet— may wear down over time. Perform regular inspections of the table and its components to detect early signs of wear, and replace parts as needed. Routine maintenance will help extend the product's lifespan.
- Heavy use may also cause the countertop surface to wear or become damaged over time. Do not service clients on a cracked, chipped, or peeling countertop, as this may cause injury. If the countertop shows signs of deterioration, please contact Customer Service to arrange repair or replacement.

T-Spa Customer Service: 888-508-8772



RISK OF ELECTRIC SHOCK

Use only indoors in dry locations.



STATE OF CALIFORNIA PROPOSITION 65 WARNING

Product may contain chemicals known to the State of California to cause cancer or reproductive harm. For more information, go to www.p65warnings.ca.gov

Power outlet hub in compliance with safety standards:



VENTILATION SYSTEM ALTERNATIVES

Manicure table ventilation system offered, produced and verified by T-SPA MFG LLC.

- Vent Head on Countertop Stones, Diameter: 4"
- Ventilation System Pipe, Diameter: 2"

1. Left & Right Side Air Vent System

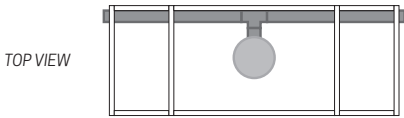
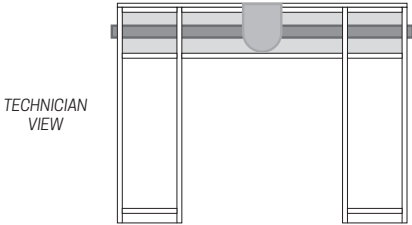

2. Left Side Air Vent System

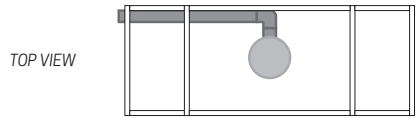
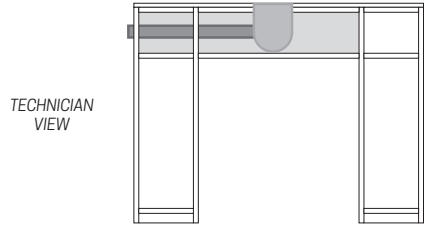

3. Right Side Air Vent System

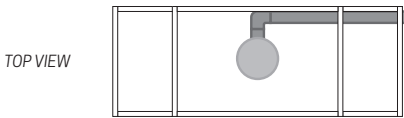
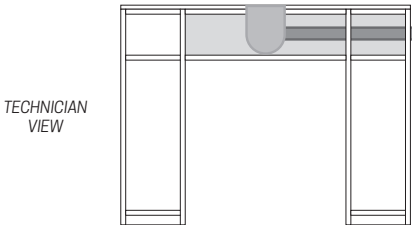

4. Down Left Leg Air Vent System

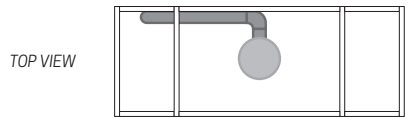
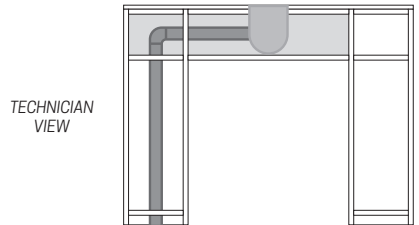

5. Down Right Leg Air Vent System

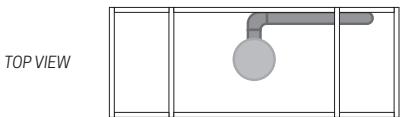
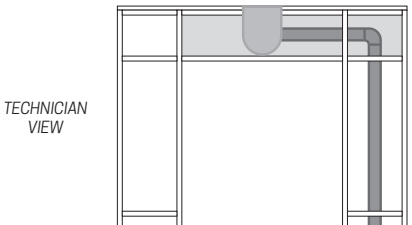

TECHNICAL SPECIFICATIONS		
Dimensions	Height	30.5" (78 cm)
	Length	43.5" (110.5 cm)
	Width	16.5" (42 cm)
Knee clearance width	24" (61 cm)	
Weight	157 lb (72 kg)	
Acetone resistant	Yes	
Color	Beige	
Countertop material	Marble Quartz	
Power outlet hub	2 AC Outlets 12A 125V AC 60Hz 1500W	
USB charger	1 USB-A & 1 USB-C Ports 5V 2A Max	
Assembly required	Yes (all required tools included)	
Trash bin	1 Included	
Hand rest cushion	1 Included	
Ventilation system	Optional upgrade	
Warranty	6 Months	

T-SPA®
WWW.TSPALLC.COM

T-SPA MFG, LLC
 10510 Kinghurst Dr
 Houston, TX 77099
 1(888)508-8772
 Info@tspallc.com