

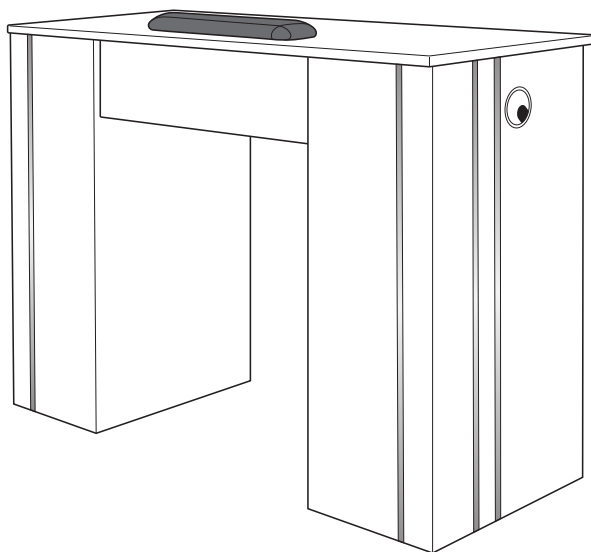

# Tiana







## Single Table

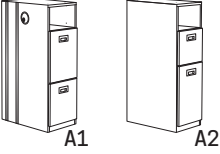
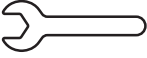
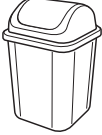

## User Manual

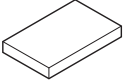
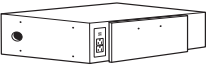
Ergonomic and elegant  
manicure single table

# ASSEMBLY

<p><b>A (x2)</b> Table Legs</p> 	<p><b>B (x1)</b> Wrench</p> 	<p><b>C (x1)</b> Trash Bin</p> 	<p><b>D (x8)</b> Wheels</p> 
<p><b>E (x1)</b> Wedge</p> 	<p><b>F (x1)</b> Top Drawer</p> 	<p><b>G (x8)</b> M3x6 Screw &amp; Washer</p> 	<p><b>H (x1)</b> Key Wrench</p> 
<p><b>I (x1)</b> Marble Countertop</p> 	<p><b>J (x1)</b> Hand Rest Cushion</p> 		

## 1. Before starting assembly

Locate the Trash Bin (C) in the lower drawer of the right leg (A2). All hardware required for assembly is stored inside the trash bin.

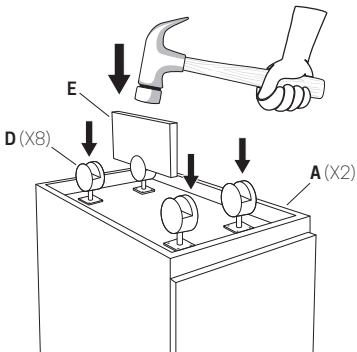
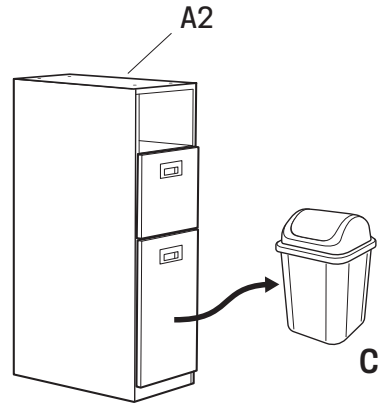

## 2. Attach the Wheels

Insert the Wheels (D) into the 4 holes at the bottom of each Table Leg (A).

Using the Wedge (E) and a hammer, gently tap each wheel until it is fully seated.

### 3. Assemble Table Legs to Top Drawer

Attach the left leg (A1) and right leg (A2) to the Top Drawer (F) using the Screws (G) and the Allen Key Wrench (H).

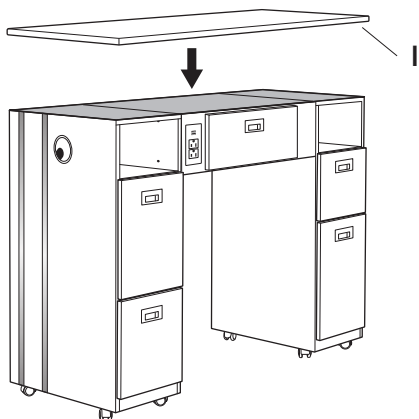
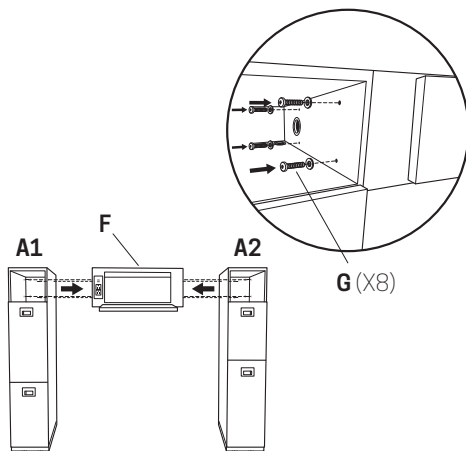

### 4. Recommended: Fasten Countertop

Secure the Marble Countertop (I) to the top of the table using glue or silicone (not included).

### 5. Finished assembly

The table is now fully assembled.

Place the Trash Bin (C) back into its drawer and position the Hand Rest Cushion (J) on the countertop.

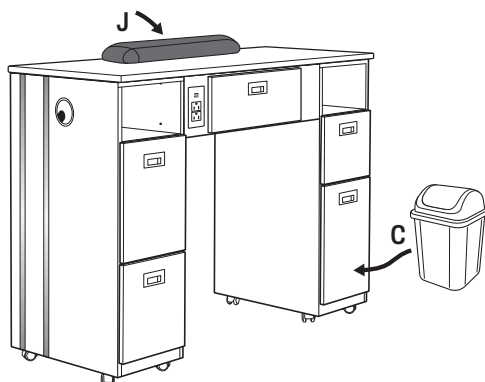

## FEATURES

### 1 | Elegant Design

Elevates your saloon style with an elegant design with sparkling granite quartz countertop and golden accents.

### 2 | Storage

Five drawers and two open shelves to have everything you need close at hand.

### 3 | Power Hub

Embedded power outlets available to connect from every drawer.

- 2 AC Outlets
- 2 Fast charging USB-A port

### 4 | Trash Bin

Includes a concealed trash bin drawer to help maintain a clean and tidy workstation.

### 5 | Wheels (x8)

Allow table free movement. Heavy duty PU wheels with PP covers to protect them from dust and dirt.

### 6 | Hand Rest Cushion

PU, acetone resistant nail cushion accessory.

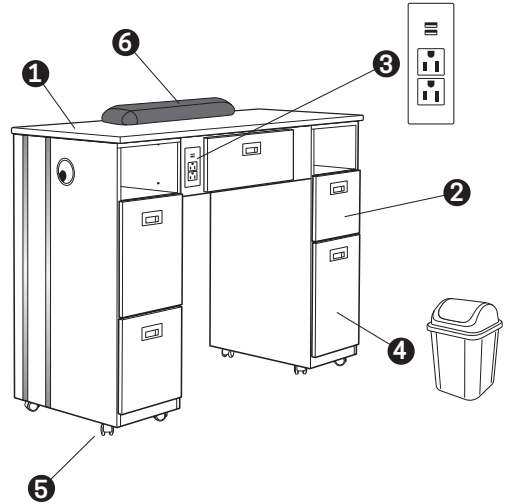

## MAINTENANCE RECOMMENDATIONS

- Clean the table and all accessories after each service using an appropriate cleaning solution or sanitizer.
- With intensive, high-volume use, the wheels may wear down over time. It is recommended to replace the table's wheels every few years, or sooner if you notice signs of wear. Regular inspections and maintenance will help extend their lifespan.
- Heavy use may also cause the countertop surface to wear or become damaged over time. Do not service clients on a cracked, chipped, or peeling countertop, as this may cause injury. If the countertop shows signs of deterioration, please contact Customer Service to arrange repair or replacement.

**T-Spa Customer Service:** 888-508-8772



#### RISK OF ELECTRIC SHOCK

Use only indoors in dry locations.



#### STATE OF CALIFORNIA PROPOSITION 65 WARNING

Product may contain chemicals known to the State of California to cause cancer or reproductive harm. For more information, go to [www.p65warnings.ca.gov](http://www.p65warnings.ca.gov)

Power outlet hub in compliance with safety standards:



# VENTILATION SYSTEM ALTERNATIVES

Manicure table ventilation system offered, produced and verified by T-SPA MFG LLC.

- Vent Head on Countertop Stones, Diameter: 4"
- Ventilation System Pipe, Diameter: 2"

## 1. Left & Right Side Air Vent System

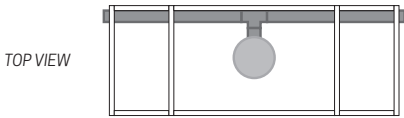
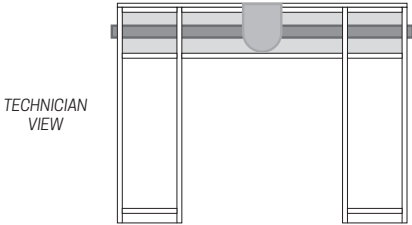

## 2. Left Side Air Vent System

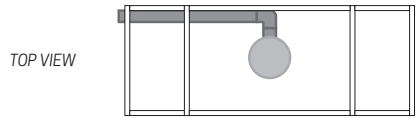
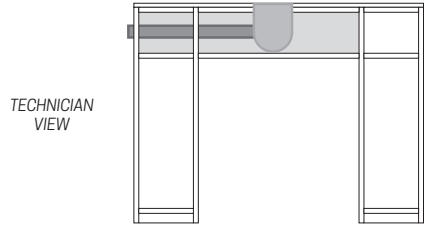

## 3. Right Side Air Vent System

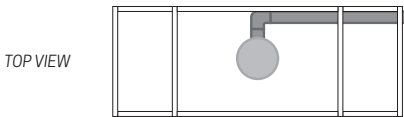
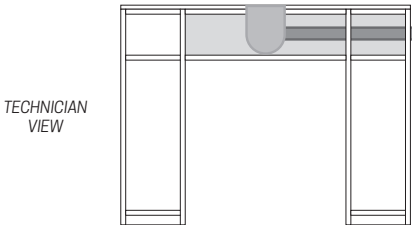

## 4. Down Left Leg Air Vent System

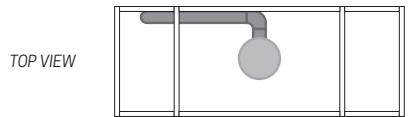
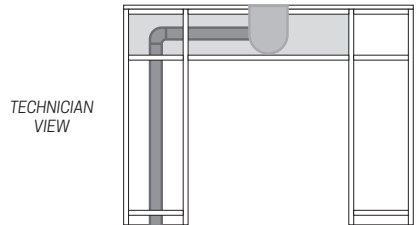

## 5. Down Right Leg Air Vent System

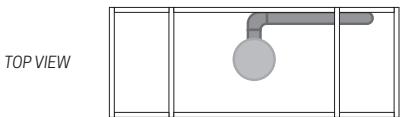
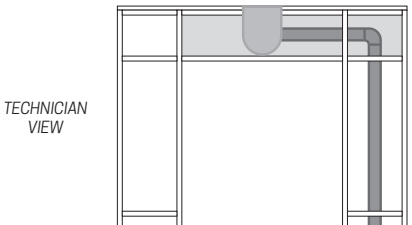

TECHNICAL SPECIFICATIONS		
Dimensions	Height	31" (79 cm)
	Length	41" (104 cm)
	Width	16.5" (42 cm)
Knee clearance width	21" (53 cm)	
Weight	157 lb (72 kg)	
Acetone resistant	Yes	
Color	White and gold	
Countertop material	Sparkling granite quartz	
Power outlet hub	2 AC Outlets 12A 125V AC 60Hz 1500W	
USB charger	2 USB-A Ports 5V 2A Max	
Assembly required	Yes (all required tools included)	
Trash bin	1 Included	
Hand rest cushion	1 Included	
Ventilation system	Optional upgrade	
Warranty	6 Months	

**T-SPA<sup>®</sup>**  
**WWW.TSPALLC.COM**

T-SPA MFG, LLC  
10510 Kinghurst Dr  
Houston, TX 77099  
1(888)508-8772  
Info@tspallc.com